

## Overview

# Cable pulley 90/8

Product number: 04200096

## Options

### PU

### Version:



## Description

Thanks to two ball bearings, the 90 mm pulley is guided particularly securely on the axle and has a high level of stability under shear loads.

The integrated spacers make it particularly easy to mount the pulley. No spacers or washers are needed.



- Impact resistant pulley
- Two ball bearings with integrated spacers
- Load capacity: up to 350 kg
- Made in Germany

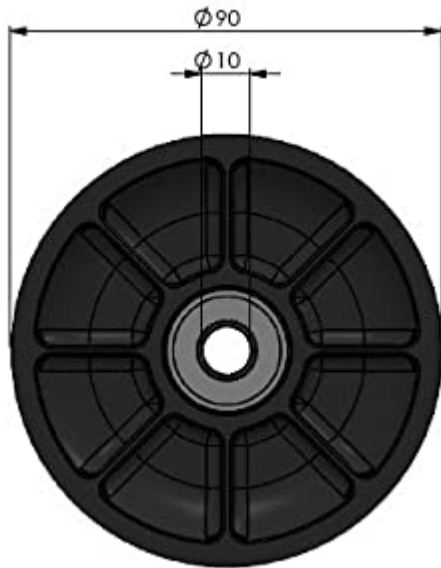

- Outer diameter: 90 mm
- compatible with 10 mm bolt



- Total width: 20 mm
- Rope diameter: up to  $\varnothing$  8 mm